

# GIO46 \_REV1.5

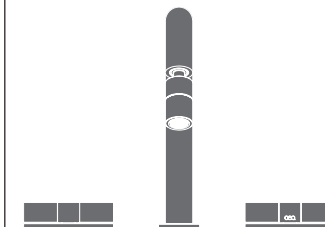

## GIO46/GIOTTO

AISI 316L STAINLESS STEEL

Rubinetteria 3 fori con bocca di erogazione orientabile

Three-hole mixer with adjustable spout

DESIGN  
NATALINO MALASORTI



Portata aeratore 5 l/min / 1.3 gpm, risparmio idrico  
Flow rate aerator 5 l/min / 1.3 gpm, water saving

## MANUTENZIONE / MAINTENANCE

NON UTILIZZARE DO NOT USE		acido clorico e muriatico <i>chloric and muriatic acid</i>
		acido fluoridrico <i>hydrofluoric acid</i>
		ipoclorito di sodio <i>chlorine bleach</i>
UTILIZZARE TO USE		detergente a pH neutro <i>neutral pH detergent</i>

Questi disegni sono proprietà di CEADDESIGN SRL s.u. pertanto non potranno essere utilizzati e/o comunicati a terzi, anche in forma parziale, senza preventiva autorizzazione. CEADDESIGN SRL s.u. si riserva il diritto di apportare modifiche ai disegni al fine di migliorare il prodotto.

CEADDESIGN SRL s.u. has the property rights on these drawings, therefore they cannot be used and/or transferred to third party, even in partial form, without any prior authorization. Furthermore CEADDESIGN SRL s.u. reserves the right to apply any change to these drawings in order to upgrade the product.

**CEA**

ceadesign.it

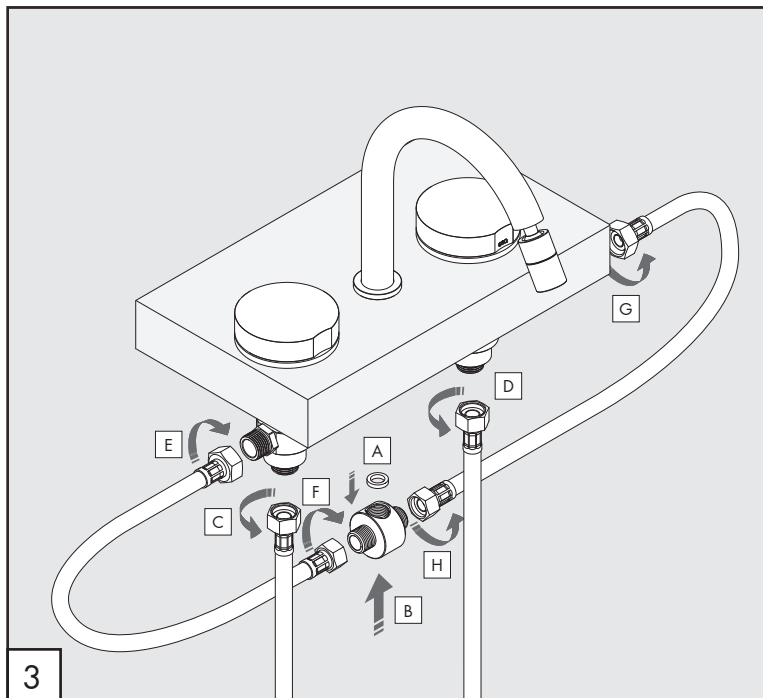
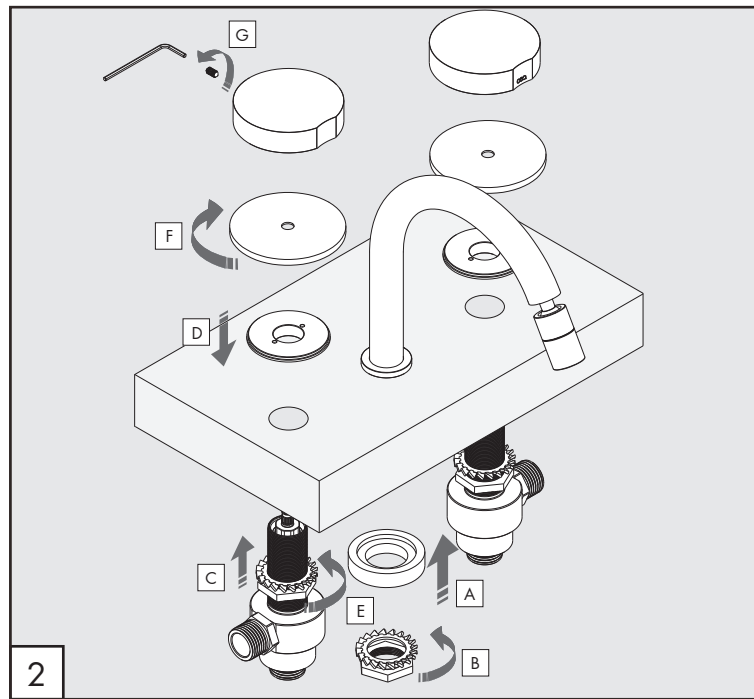
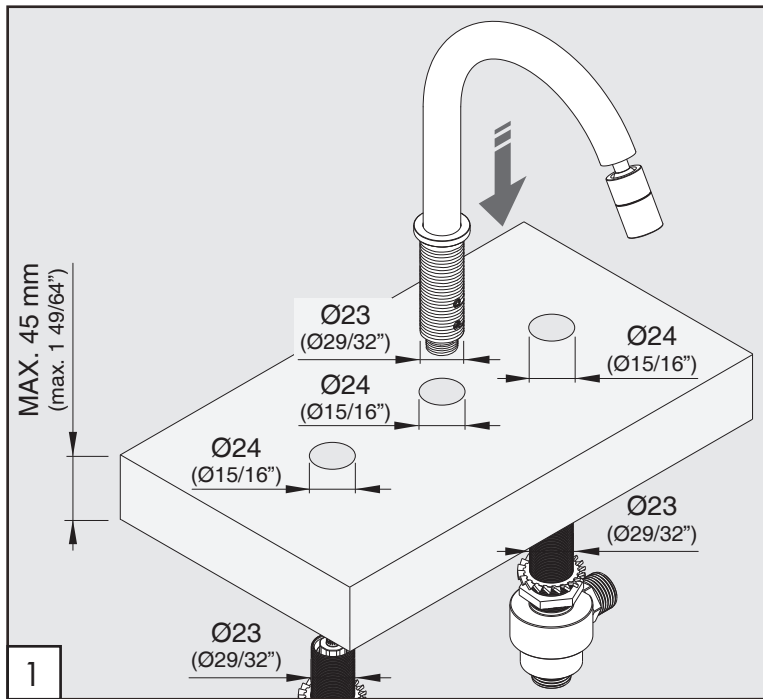

PULIZIA / CLEANING / SAUBEKEIT / LIMPIEZA / NETTOYAGE

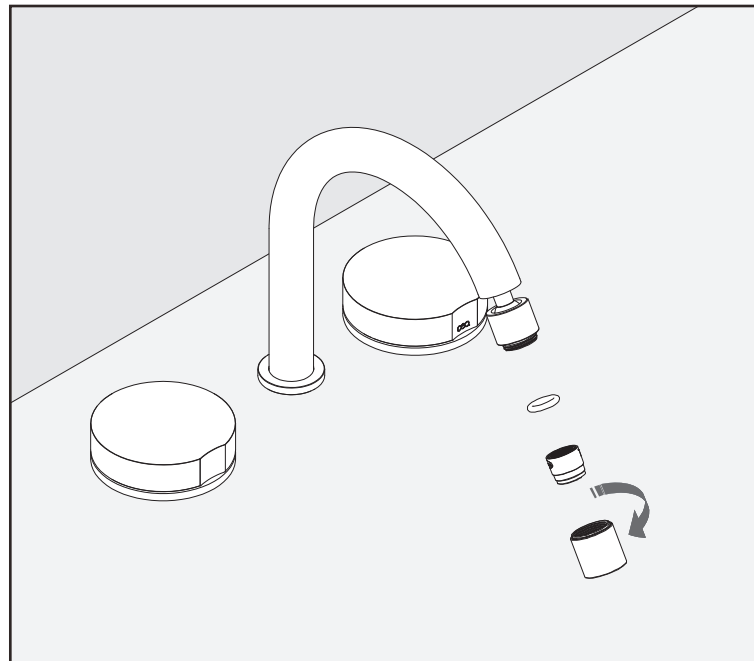

# GIO46

\_REV1.5

## AVVERTENZE TECNICHE

Risciacquare bene le tubazioni prima del montaggio ed evitare sbalzi di pressione fra i raccordi d'acqua fredda e d'acqua calda. In caso di pressioni statiche superiori a 5 bar si raccomanda l'installazione di un riduttore di pressione per evitare danni al vitone.

## TECHNICAL WARNINGS

The pipes have to be rinsed thoroughly before installation. Avoid pressure differences between hot and cold water supply. Use of a pressure reducer when static pressure is higher than 5 bar to avoid damage of the shut-off valve.

## TECHNISCHE WARNUNG

Spülen Sie die Leitungen vor dem Einbau und verhindern Sie Wasserdruckwechsel zwischen kalt und warm Wasserverbindungen. Wenn Wasserdruck größer als 5 bar ist, bitte reduzieren Sie den Systemdruck, um Beschädigung der Ventil zu verhindern.



## ADVERTENCIA TÉCNICA

Los tubos tienen que ser enjuagados a fondo antes de la instalación. Evitar grandes diferencias de presión entre las conexiones de agua caliente y fría. En caso de presión estática mayor de 5 bar, se recomienda el uso de un adaptador de presión para evitar daños en la válvula.

## ADVERTISSEMENTS TECHNIQUES

Rincer les tuyaux avant l'installation. Eviter des grandes différences de pression entre l'eau froide et chaude. En cas de pressions statique de plus de 5 bar, nous vous recommandons d'installer un réducteur de pression pour éviter des dommages à la vanne d'ouverture/d'arrêt.

## TEMPERATURA DI ESERCIZIO / WORKING TEMPERATURE

 max. 65 °C  
 max. 149 °F

# CEQ

FISSAGGIO OPZIONALE BOCCA DI EROGAZIONE / SPOUT OPTIONAL FIXING /  
OPTIONALER BEFESTIGUNG DES AUSLAUF / FIJACIÓN OPCIONAL DE CAÑO /  
OPTION DE FIXATION DU BEC

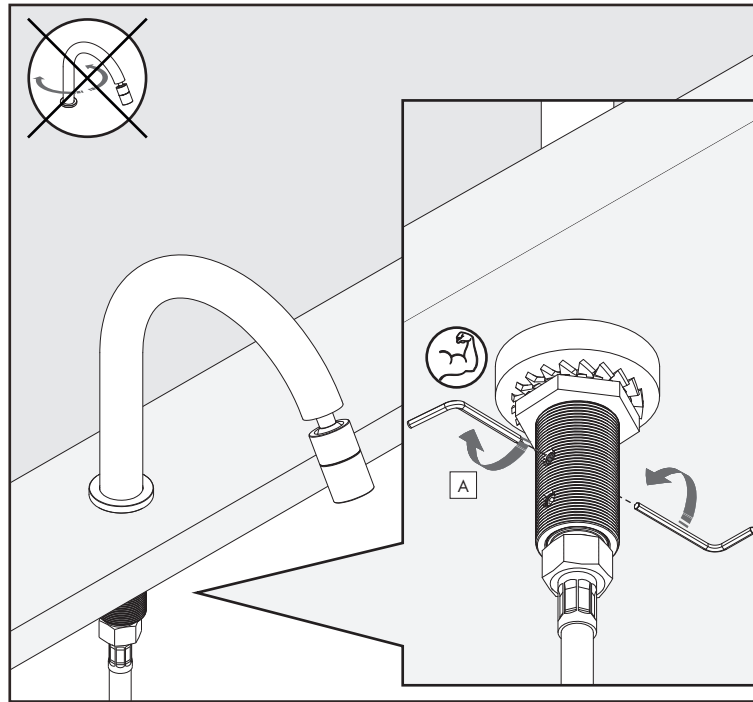
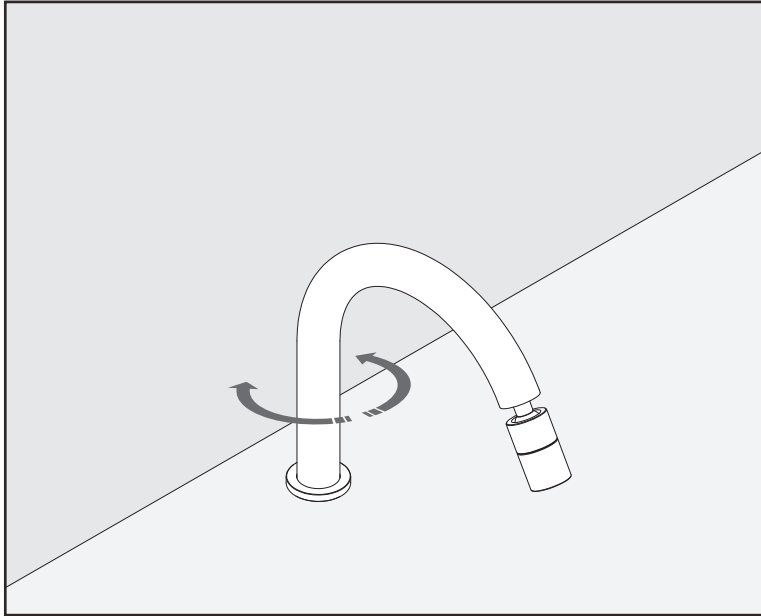

GIO46\_REV1.5

AERATORE IN DOTAZIONE / AERATOR INCLUDED

 **Aeratore montato / Mounted aerator**  
5 l/min / 1.3 gpm

AERATORI SU RICHIESTA / AERATORS ON DEMAND

 Conforme agli standard LEED / Compliant with LEED standards  
1,9 l/min / 0,5 gpm

 Conforme agli standard LEED / Compliant with LEED standards  
3,8 l/min / 1 gpm

**CEQ**

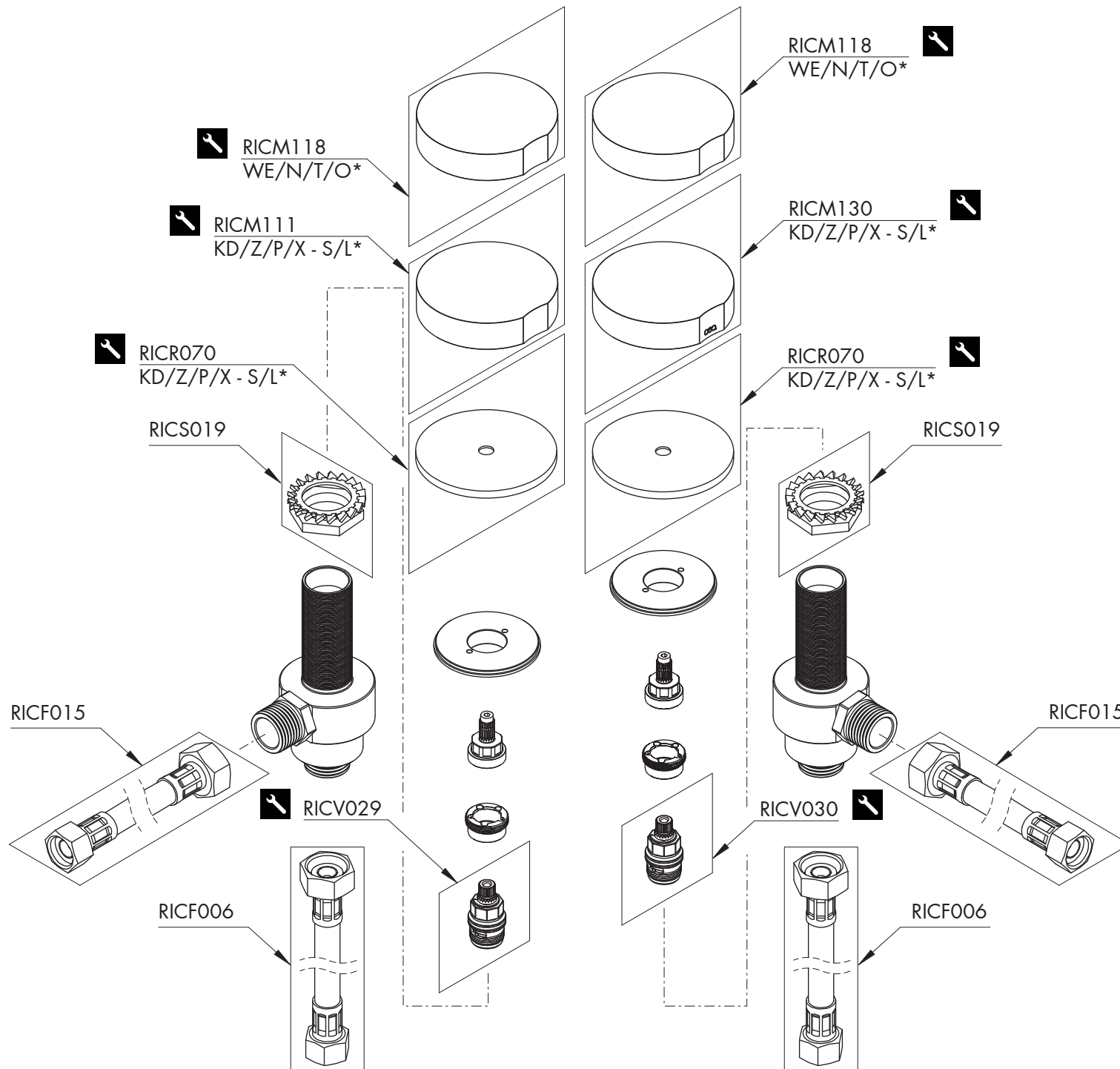

## RICAMBI / SPARE PARTS

RICM111	Maniglia / Handle
RICM118	Maniglia / Handle
RICM130	Maniglia / Handle
RICF006	Flessibile / Hose
RICF015	Flessibile / Hose
RICR070	Rosetta / Rosette
RICS019	Kit di fissaggio / Fixing kit
RICV029	Vitone / Shut-off valve
RICV030	Vitone / Shut-off valve

**⚠** Conservare gli strumenti inclusi nel prodotto e utilizzati per l'installazione perchè riutilizzabili per i ricambi.

Please, keep the tools included in the item pack and employed for its installation, to re-used them for the spare parts.

Die im Produkt enthaltenen Werkzeuge aufbewahren, da sie für die Ersatzteile wiederverwendet werden können.

No tirar las herramientas incluidas en el producto y usadas durante la instalación puesto que se pueden reutilizar para los recambios.

Veillez conserver les outils inclus dans la boîte du produit et employés pour son installation, parce que réutilisables pour les pièces de rechange.

## LEGENDA / LEGEND

### ICONE / ICONS

**⚠** Utensile incluso nel ricambio  
Tool included in spare part

### FINITURE / FINISHES

\*S finitura satinata / satin finish  
L finitura lucidata / polished finish

### FINITURE SPECIALI / SPECIAL FINISHES

KD black diamond  
Z bronzo / bronze  
P rame / copper  
X light gold

### ESSENZE LEGNO / WOOD ESSENCES

\*WE wengè / wenge  
N noce americano / american walnut  
T teak birmano / burma teak  
O rovere / oak

## RICAMBI / SPARE PARTS

<b>RICA002</b>	<b>Aeratore / Aerator</b>	<b>5 l/min / 1.3 gpm</b>
RICR007	Rosetta / Rosette	
RICS003	Kit di fissaggio / Fixing kit	
RICT005	Raccordo / Fitting	

## AERATORI SU RICHIESTA / AERATORS ON DEMAND

RICAO57	Aeratore / Aerator	1,9 l/min / 0.5 gpm
RICAO58	Aeratore / Aerator	3,8 l/min / 1 gpm

## ROSETTA SU RICHIESTA / ROSETTE ON DEMAND

RICR142	Rosetta Ø esterno 45 mm Rosette external Ø 45 mm
---------	---

## ROSETTA SU RICHIESTA / ROSETTE ON DEMAND

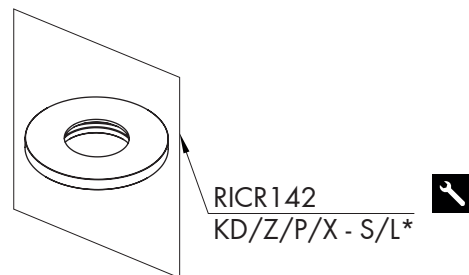

## AERATORE IN DOTAZIONE / AERATOR INCLUDED

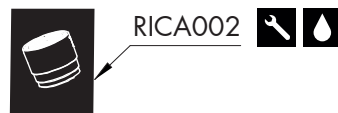

## AERATORI SU RICHIESTA / AERATORS ON DEMAND

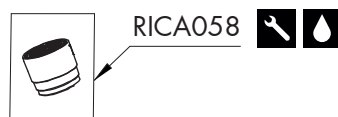
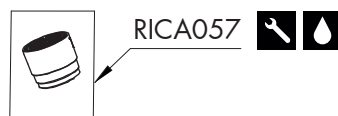



 RICR007  
KD/Z/P/X - S/L\*

RICS003

RICT005

## LEGENDA / LEGEND

### ICONE / ICONS

-  Aeratore a risparmio idrico, utilizzabile per lavabo  
*Water saving aerator, suitable for wash-basin*
-  Utensile incluso nel ricambio  
*Tool included in spare part*

### FINITURE / FINISHES

- \*S finitura satinata / *satin finish*
- L finitura lucidata / *polished finish*

### FINITURE SPECIALI / SPECIAL FINISHES

- KD black diamond
- Z bronzo / *bronze*
- P rame / *copper*
- X light gold