

Belgravia Wall Tub Spout US-BL0370

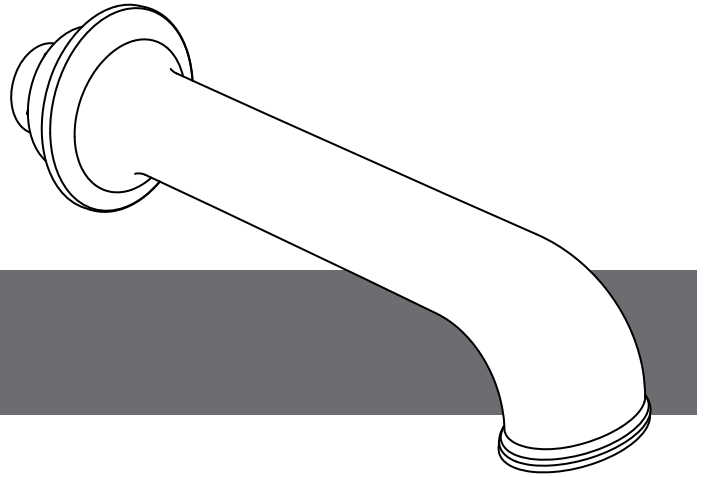

Installation Instructions



Introduction

The wall spout has been fully inspected throughout the production process and only leaves our factory after a 15-step QC process. Carefully remove the spout from the box and check that all parts have been supplied.

Before beginning installation please check for any damage that may have occurred during transport. **Note: Damage claims cannot be made during or after installation.**

Improper installation shall result in loss of warranty in case of damage caused by impacts or rubbing against rough surfaces. Prior to installing the wall spout prepare a connection of water inlet/outlet.

IMPORTANT: Please read these instructions carefully before beginning and retain for future reference.

We do not accept responsibility for any problems that may occur through incorrect installation.

Installation notes

The installation must comply with all plumbing codes including local codes and be installed by a licensed plumbing contractor.

Anti-scald protection is the responsibility of the installer and according to applicable codes.

IMPORTANT! Before installation it is essential that the supply pipes are thoroughly flushed in order to remove any remaining debris, solder or other impurities. Failure to carry out this simple procedure can cause problems or damage to the working of the wall spout.

Installing shut-off valves on incoming supply lines is recommended for ease of maintenance.

Turn off the main water supply before connecting to any existing pipework or doing any maintenance.

WARNING! Please check for any hidden pipes and cables, electric or otherwise, before drilling holes in a wall or floor.

Dimensions

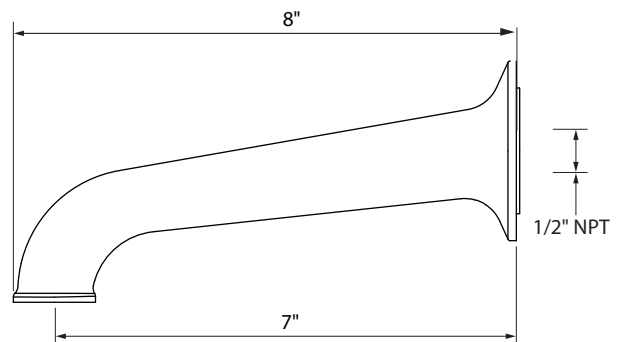
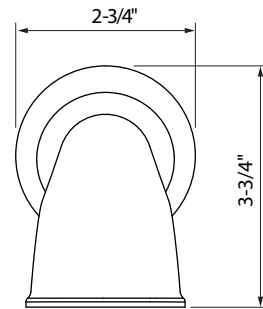

Tools required

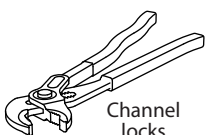

Channel locks

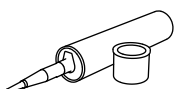

Plumbers' putty or caulking

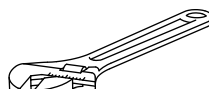

Adjustable wrench

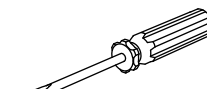

Flat head screwdriver

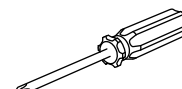

Cross head screwdriver



Hexagonal key

1 Installation

- Shut off the water heating system then, with the main water supply **turned off**, open the lowest hot and cold faucets and allow to drain until supply pipes are empty.
- Identify all components before fitting.

ATTENTION: Check all new connections for leaks.

- Turn on the main water supply, close all faucets except for the new installed spout and faucet and as the system refills, check for leaks.
- Once satisfied there are no leaks, switch on the heating system.

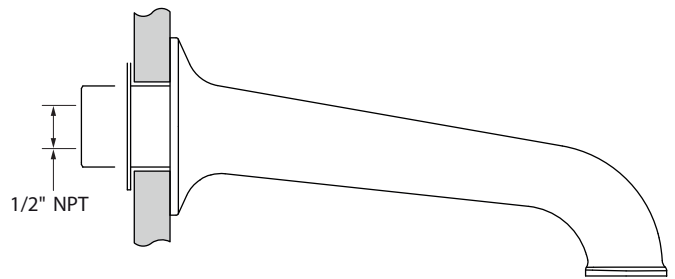

2 Parts list

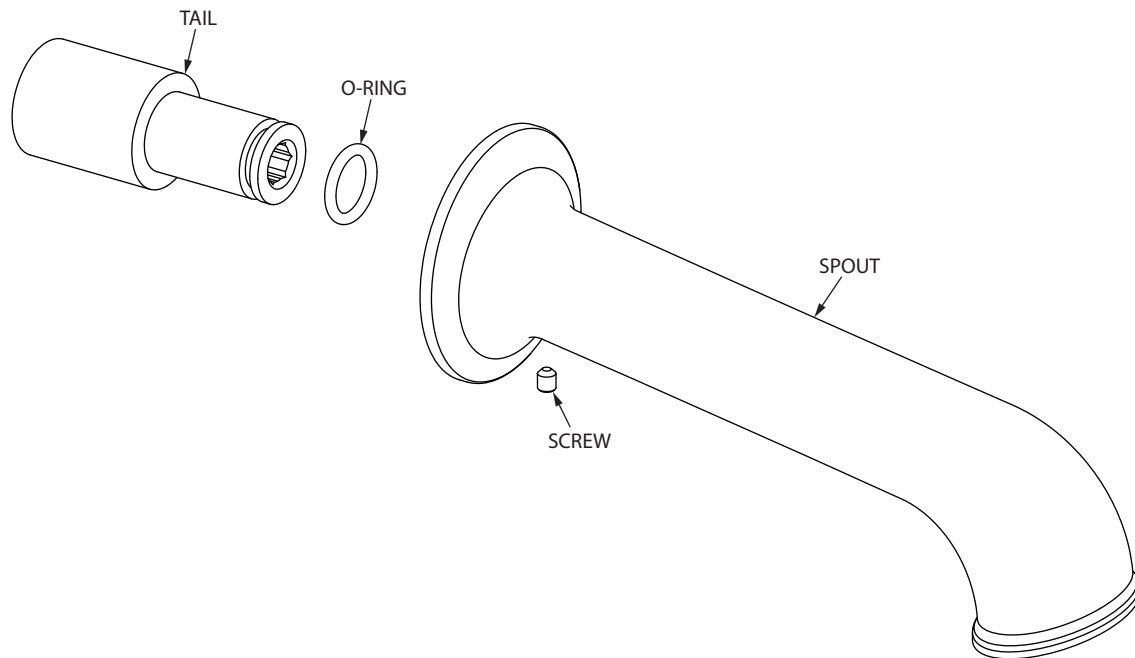

3 Cleaning Instructions

Rinse away any traces of soap and gently dry with a clean, soft cloth after each use. Rinse completely with water and dry any overspray. This will maintain the finish and avoid water spotting.

To remove mineral deposits, use a 50/50 solution of white vinegar and water. Do not allow the solution to soak on the product.

Simichrome Polish® contains a protective film to enhance maintenance and is helpful in preventing water spot buildup. Follow instructions to ensure optimum results.

Never use an abrasive material such as a brush or scouring pad to clean the surface. The use of abrasive cleaners, cleansers or disinfectants will alter the surface finish and void the warranty.

Do not allow certain materials such as toothpaste, cologne, shaving cream, nail polish remover, vinegar, wine, drain and glass cleaners to remain on the surface. Prolonged contact will alter surface finishes and void the warranty.

We DO NOT recommend using any household cleaners as many can cause damage to the finish.

Please see the website for care instructions for specific finishes.

Warranty - This **Crosswater London** product is covered by a limited lifetime warranty. For full details, terms and conditions please visit our website.

For further information contact: **Crosswater London**, 393 Fortune Blvd., Milford, MA 01757

www.crosswaterlondon.com

Toll free number: 844-XWATER-1 (844-992-8371) tel: 508-381-0433 fax: 508-381-6068

email: technical@crosswaterlondon.com

Issue date: 15092019