

SHOWER
Full Pressure Balancing System -
Tub & Shower
G-7215-LM48S

GRAFF®



Information

- 1/2" pressure balance valve with diverter and trim
- 9" showerhead with 11" wall-mounted shower arm
- Showerhead features no-clog, easy-clean spray nozzles
- 8" matching Camden collection tub spout
- Optional extension kit
- Showerhead flow rate ≤ 1.8 max gpm
- CALGreen

SHOWER
8" Camden Tub Spout
G-6965

GRAFF®



Information

- Includes spout ring
- 1/2" NPT male thread inlet
- Tub spout flow rate ~ 13.9 gpm @60 psi
- ADA

Finishes

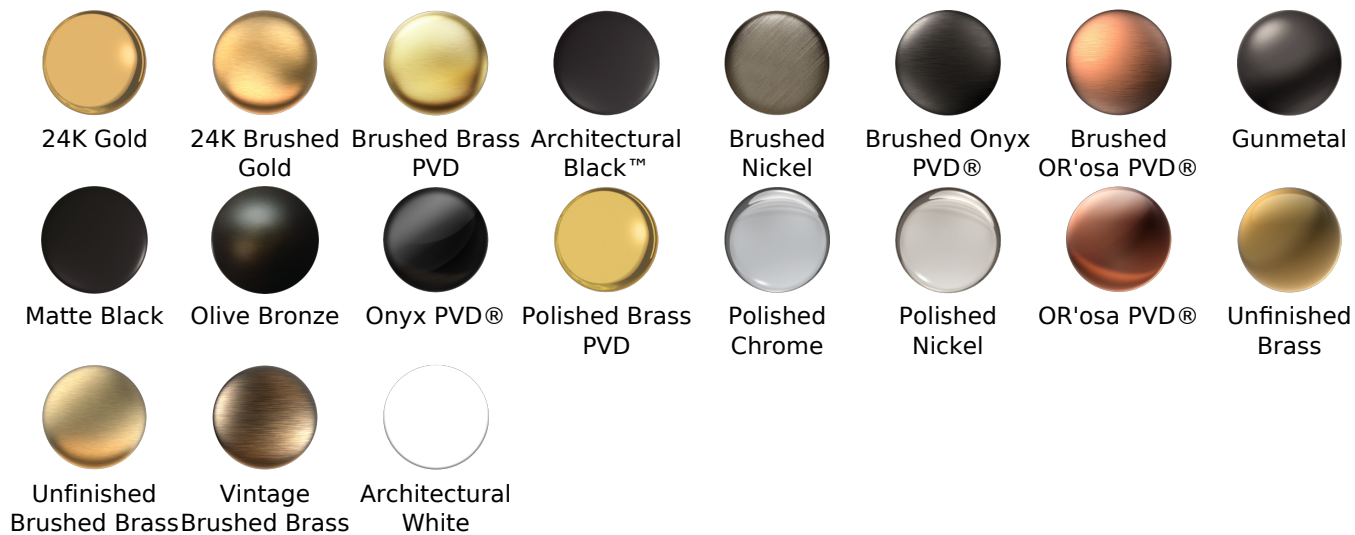

G-6965

Camden Collection
8" Camden Tub Spout

GRAFF[®]
CUTTING EDGE DESIGN



Product Features

- Includes spout ring
- 1/2" NPT female thread inlet
- Tub spout flow rate ~ 13.9 @60 psi

Available Finishes

- Polished Chrome
G-6965-PC
- Brushed Nickel
G-6965-BNi
- Polished Nickel
G-6965-PN
- Olive Bronze
G-6965-OB
- Unfinished Brass*
G-6965-UB*
- Gold*
G-6965-AU*
- Brushed Gold*
G-6965-BAU*

* Special order finish- call for availability

Code Compliance

- CALGreen

Warranty

- Limited lifetime warranty

For complete warranty information go to
<https://www.graff-faucets.com/en/info/faqs>

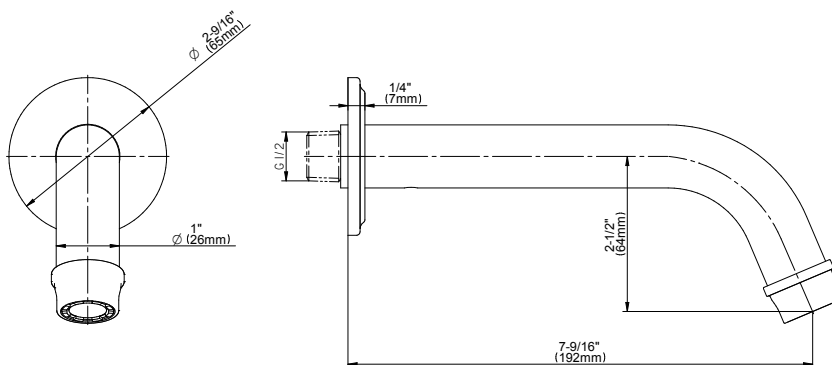

The measurements shown are for reference only. Products and specifications shown are subject to change without notice. Revised 5/2018.

www.graff-designs.com | phone: 800-954-4723

SHOWER
 Concealed Pressure Balancing
 Valve Rough w/Diverter
G-7055



Information

- Anti-scald protection
- 1/2" universal inlets/outlets with male threads
- Built-in service stops
- Push-button diverter
- For use with tub & shower configuration
- Supplied with protective plastic guard

Finishes



G-7055

1/2" Rough Valve w/Diverter



Product Features

- Anti-scald protection
- 1/2" universal inlets/outlets with male threads
- Built-in service stops
- Push-button diverter
- For use with tub & shower configuration
- Supplied with protective plastic guard

Warranty

- Limited lifetime warranty

For complete warranty information go to www.graff-faucets.com/en-nam/warranty

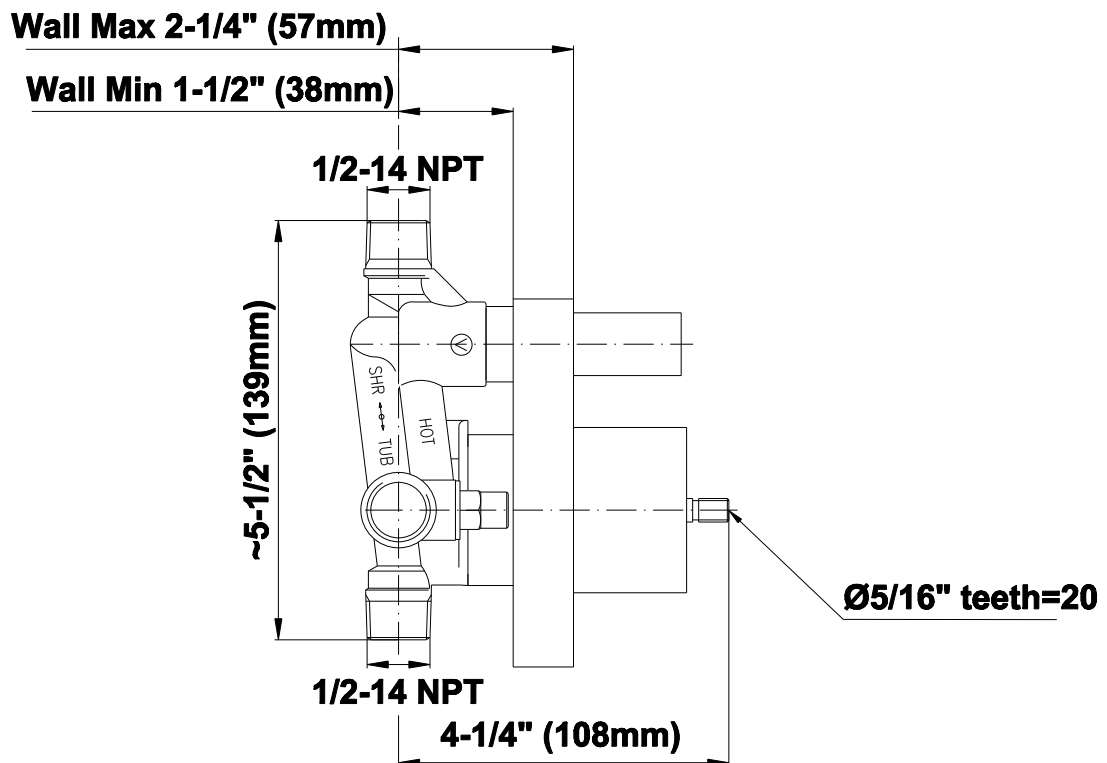

The measurements shown are for reference only. Products and specifications shown are subject to change without notice. Revised 06/2014.

www.graff-faucets.com | phone: 800-954-4723















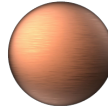

SHOWER
 Pressure Balancing Valve Trim
 with Handle & Diverter
G-7095-LM48S-T



Information

- Single metal handle, decorative trim plate
- Includes push-button diverter
- Use with G-7055 pressure balancing rough valve
- Available Fall 2017- Call for earlier availability
- ADA

Finishes

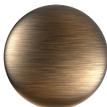
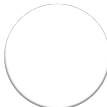
							
24K Gold	24K Brushed Gold	Brushed Brass PVD	Architectural Black™	Brushed Nickel	Brushed Onyx PVD®	Brushed OR'osa PVD®	Gunmetal
							
Matte Black	Olive Bronze	Onyx PVD®	Polished Brass PVD	Polished Chrome	Polished Nickel	OR'osa PVD®	Unfinished Brass
							
Unfinished Brushed Brass	Vintage Brushed Brass	Architectural White					

G-7095-LM48S-T

Camden Collection

Pressure Balancing Valve Trim with Handle & Diverter

GRAFF®



Product Features

- Single metal handle, decorative trim plate
- Includes push-button diverter
- Use with G-7055 pressure balancing rough valve

Available Finishes

- Polished Chrome
G-7095-LM48S-PC-T
- Brushed Nickel
G-7095-LM48S-BNi-T
- Polished Nickel
G-7095-LM48S-PN-T
- Olive Bronze
G-7095-LM48S-OB-T
- Unfinished Brass*
G-7095-LM48S-UB-T*
- Gold*
G-7095-LM48S-AU-T*
- Brushed Gold*
G-7095-LM48S-BAU-T*

* Special order finish- call for availability

Warranty

- Limited lifetime warranty

For complete warranty information go to <https://www.graff-faucets.com/en/info/faqs>

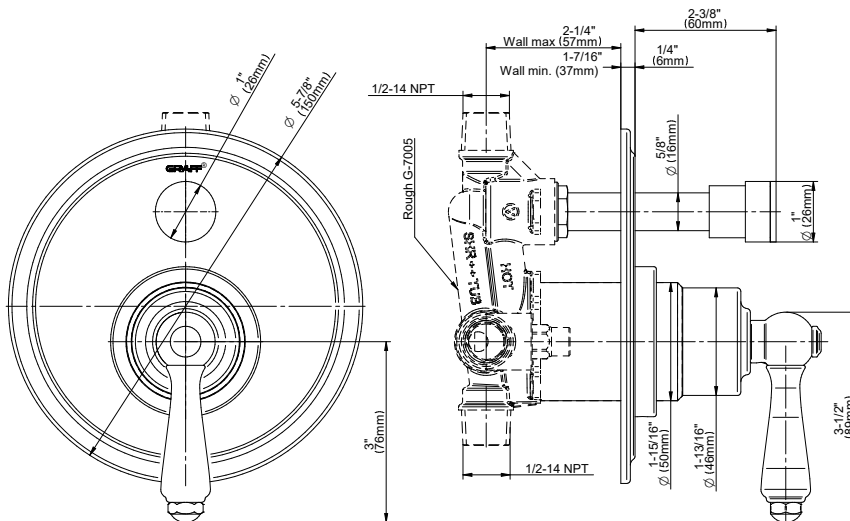

The measurements shown are for reference only. Products and specifications shown are subject to change without notice. Revised 03/2018.

www.graff-designs.com | phone: 800-954-4723



Information

- 126 no-clog, easy-clean rubber spray nozzles
- Recommended use with ceiling shower arm
- Recommended for use at no more than 10 degrees tilt
- Showerhead flow rate ≤ 1.8 max gpm
- CALGreen

Finishes

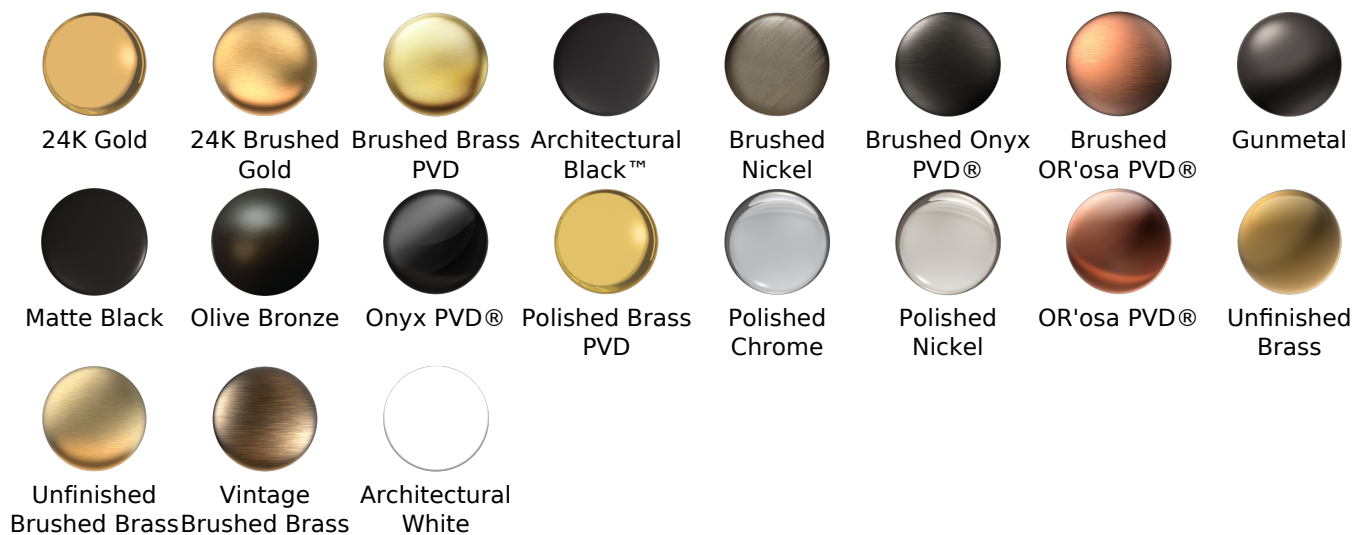

G-8406

Finezza Collection
9" Rain Showerhead

GRAFF[®]
CUTTING EDGE DESIGN

Product Features

- Sunflower shape
- 126 no-clog, easy-clean rubber spray nozzles
- Showerhead flow rate < 1.8 max gpm



Available Finishes

- Polished Chrome
G-8406-PC
- Brushed Nickel
G-8406-BNi
- Polished Nickel
G-8406-PN
- Unfinished Brass*
G-8406-UB*
- Olive Bronze
G-8406-OB*
- Gold*
G-8406-AU*
- Brushed Gold*
G-8406-BAU*

* Special order finish- call for availability

Code Compliance

- CALGreen

Warranty

- Limited lifetime warranty

For complete warranty information go to
www.graff-designs.com/en-nam/warranty

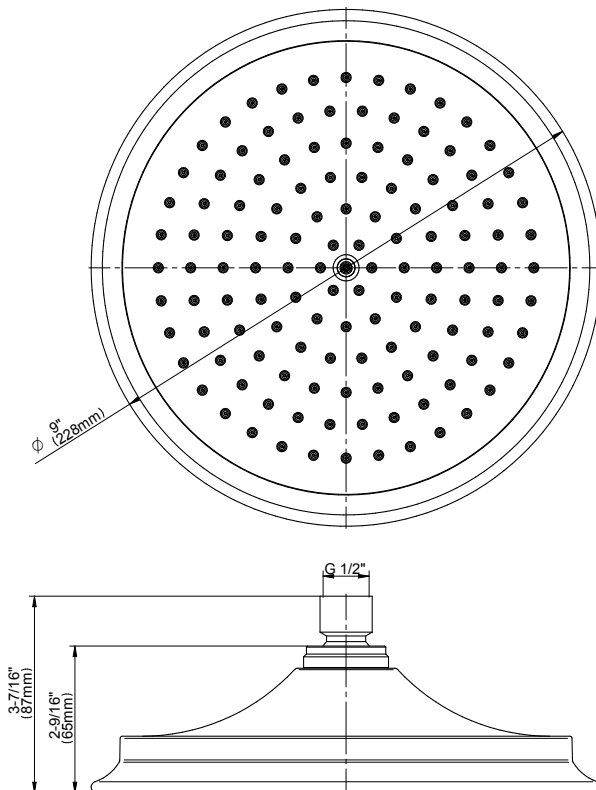

The measurements shown are for reference only. Products and specifications shown are subject to change without notice. Revised 12/2017

www.graff-designs.com | phone: 800-954-4723

SHOWER
 Transitional 11" Shower Arm
G-8508



Information

- Includes arm and flange
- 1/2" NPT male thread inlet
- For use with all showerheads

Finishes

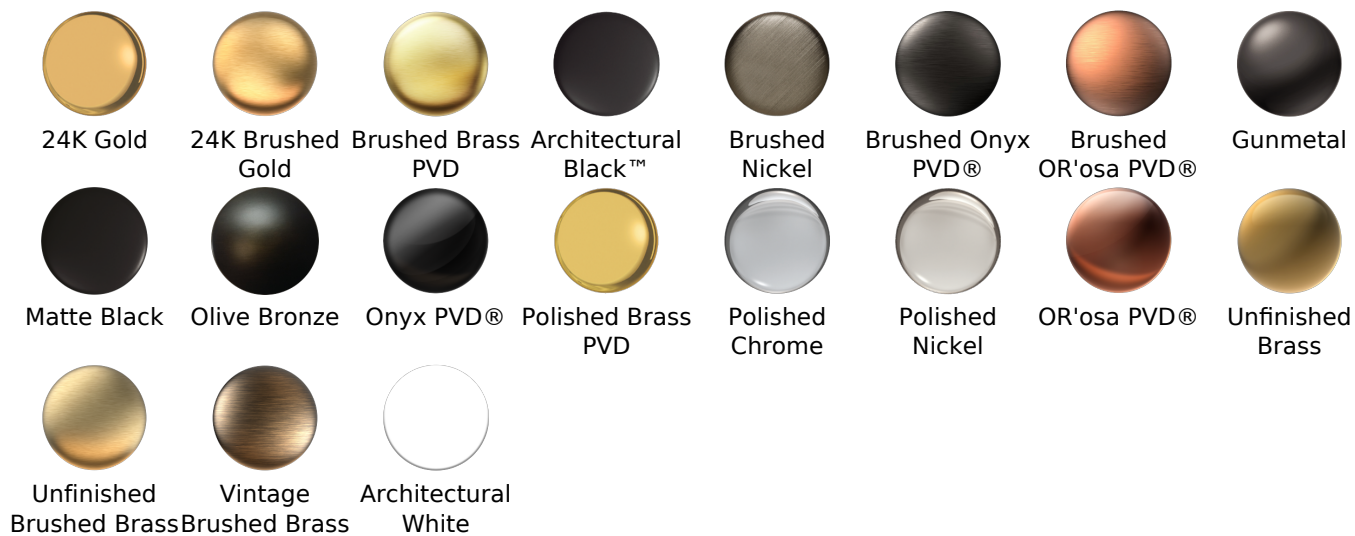

G-8508

Transitional 11" Shower Arm

GRAFF®



Product Features

- Includes arm and round flange
- 1/2" NPT male thread inlet
- For use with all showerheads

Warranty

- Limited lifetime warranty

For complete warranty information go to <https://www.graff-faucets.com/en/info/faqs>

Available Finishes

- Polished Chrome
G-8508-PC
- Brushed Nickel
G-8508-BNi
- Polished Nickel
G-8508-PN
- Unfinished Brass*
G-8508-UB*
- Unfinished Brushed Brass*
G-8508-UBB*
- Matte Black*
G-8508-MBK*
- Architectural Black*
G-8508-BK*
- Architectural White*
G-8508-WT*
- Steelnox (Satin Nickel)*
G-8508-SN*
- Olive Bronze*
G-8508-OB*
- Gunmetal*
G-8508-GM*
- Vintage Brushed Brass*
G-8508-VBB*
- OR'osa PVD*
G-8508-RG*
- Onyx PVD*
G-8508-OX*
- Polished Brass PVD*
G-8508-PB*
- Brushed Brass PVD*
G-8508-BB*
- 24K Gold*
G-8508-AU*
- 24K Brushed Gold*
G-8508-BAU*

* Special order finish- call for availability

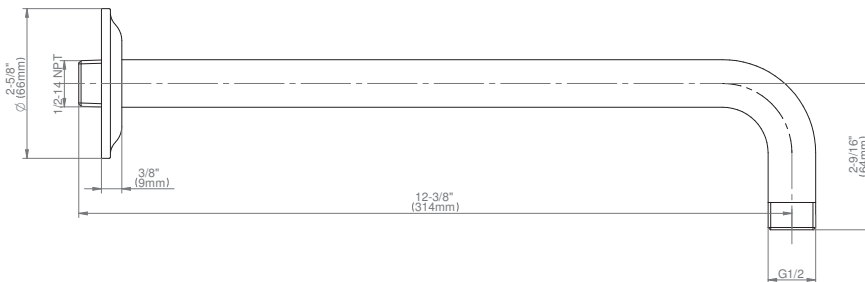

The measurements shown are for reference only. Products and specifications shown are subject to change without notice. Revised 7/2019.

www.graff-designs.com | phone: 800-954-4723