

M 5 Specification

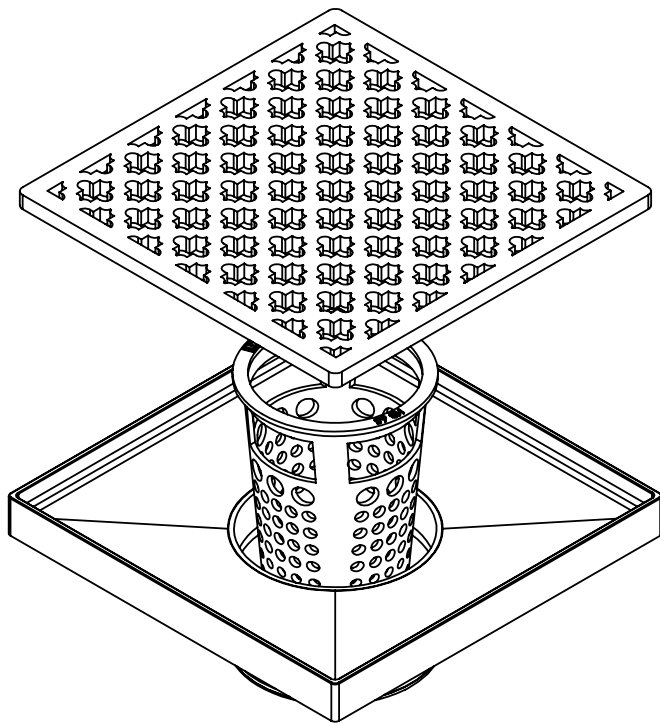

M 5:

- 5" x 5" 304L stainless steel strainer assembly with 2" throat

Kit includes:

- 1 - MS 5 - 5" x 5" Stainless steel decorative plate
- 1 - T 52 - Stainless steel 2" throat with mud guard
- 1 - HMK - C2-D Hair maintenance kit:
 - 1 - HB 65 Hair basket
 - 1 - DKEY Lift out key

Finishes:

- Satin Stainless
- Polished Stainless
- Oil Rubbed Bronze
- Satin Bronze
- Matte Black

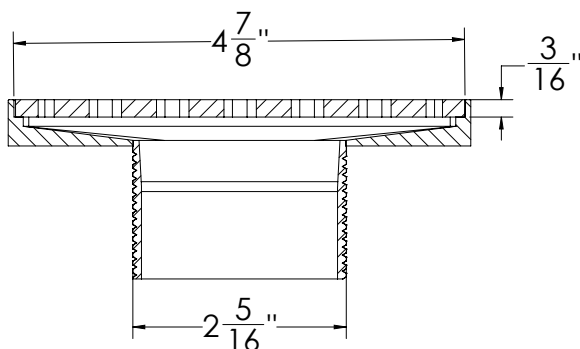
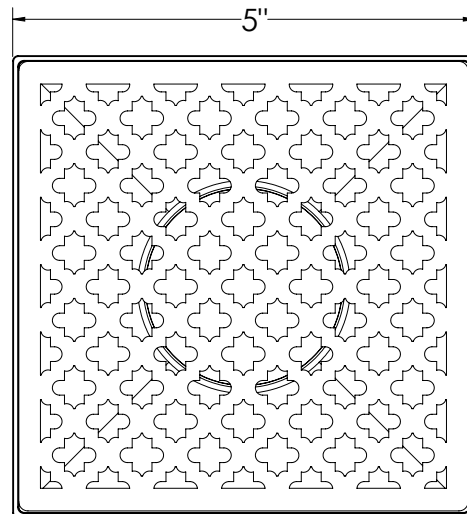

SECTION 1-1

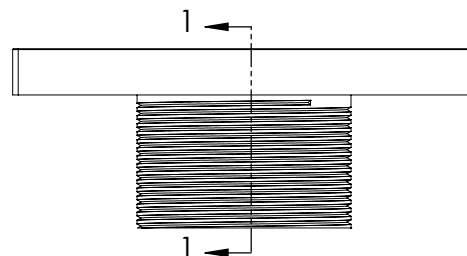

Infinity Drain
145 Dixon Avenue
Amityville, NY 11701
Phone: 516.767.6786
Fax: 516.740.3066
www.infinitydrain.com



NOTE: Installer must verify all rough-in dimensions prior to installation and consult local and national codes. Conformity and compliance to local and national codes are the responsibility of the installer.