

Grab rail set bent end f/ barrier-free

Knud Holscher collection

Product cc 300mm.

Tender text

Knud Holscher collection, grab bar set, bent end, cc 300mm, self-tapping screws included. Manufactured in the highest quality marine grade, AISI 316 stainless steel, protecting against high levels of corrosion. Certified in accordance with EN 12182. 20-year warranty.

Product specification Dimensions: 72x498x82mm
Diameter: Ø32mm
Material: stainless steel AISI 316
Surface finish: satin grain 320, crafted by hand
[20-year warranty \(5 years for coated items\)](#)

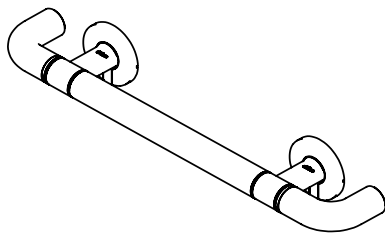
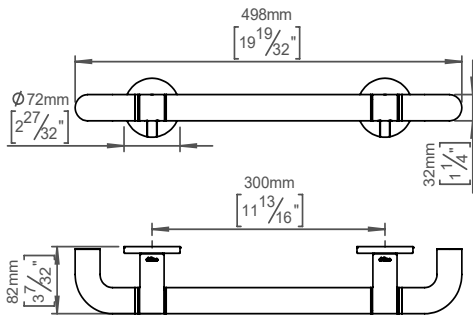

Available finishes

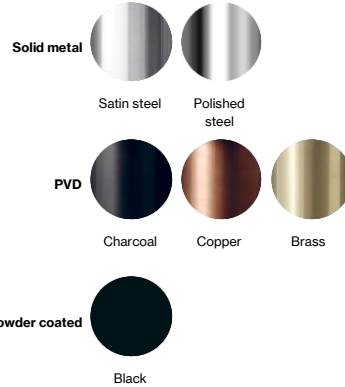

Spare parts/ accessories

Mounting

<https://dline.com/mounting-instructions/>

Product care

d line products are produced in the highest quality marine grade AISI 316 stainless steel. To sustain the unique d line finish please follow the below instructions:

- Wash down the surfaces using soapy water or mild detergent
- Always thoroughly rinse off with clean water
- To complete the cleaning procedure dry/polish the surface with a soft dry cloth

Please do not use scouring powder, steel wool, chloride based detergents or other aggressive cleaning products as these may damage the surface.

If spots or corrosion appear on the surface it is not due to the stainless steel quality, but to impurities in the environment, aggressive conditions or improper or insufficient cleaning.